

NAE-VHS-100-4-PWS

NEMA Standard Vertical Hollow Shaft Motor

Energy Efficient – Three Phase – ODP – WP1-AC Motor-Suitable for Part Wind Start

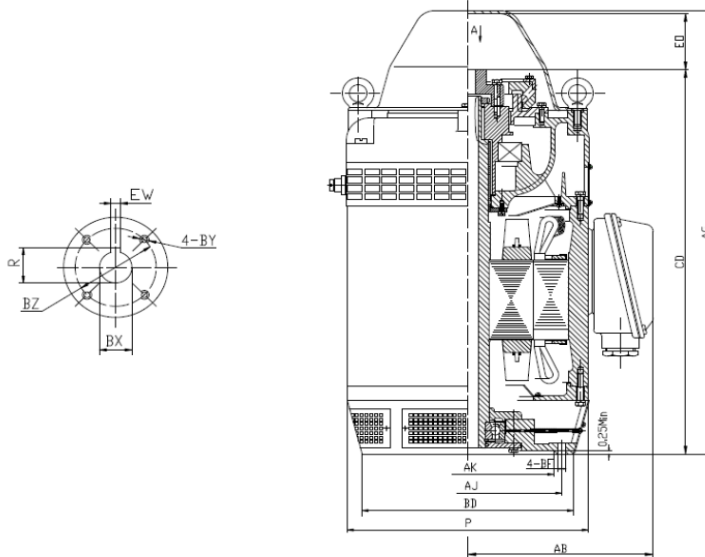

DIMENSIONS – INCHES

BD	AJ	AK	BF	BZ	EW	R	BY	CD	EO >	AC
16.5	14.75	13.5	0.69	2.125	0.375	1.668	1/4-20	36.94	4.56	13.58
AA	AF	P	AB	AG	Upper Bearing Oil Capacity		Down Thrust	BX		
3.0	5.83	21.0	17.0	42.2	6.5		6700 lbs	1.50		

NOTE: Optional BX Coupling Dimensions Available.

PERFORMANCE DATA

Three Phase – 60Hz - 460V – NEMA Design B - Max. Ambient: 40° C

HP	Speed	Frame	NEMA Code	Efficiency (%)			Power Factor %			Torque (ft-lb)		
				100%	75%	50%	100%	75%	50%	FLT	BDT%	LRT%
100	1770	404TP	C	92.3	92.1	91.7	88.0	88.0	82.0	405.3	242	215
Amps (460V)		Angular Contact Bearing	Radial Ball Bearing	Insulation Class	Enclosure Type	Service Factor	Weight (lbs)					
FLA	LRA											
111.95	727.17	7230B	6317	F	ODP	1.15	1399					



North American Electric, Inc. 350 Vaiden Drive, Hernando, MS 38632

Toll Free: 1-800-884-0405 Phone: 662-429-8049 Fax: 662-429-8546

www.naemotors.com

Across The Line Start 12 Lead DELTA Connection 460V 60Hz

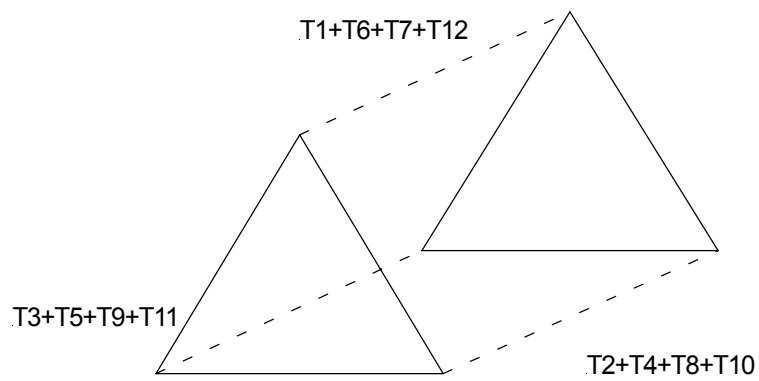

L1	L2	L3
T1+T6+T7+T12	T2+T4+T8+T10	T3+T5+T9+T11

Part Wind Start 12 Lead DELTA Connection 460V 60Hz

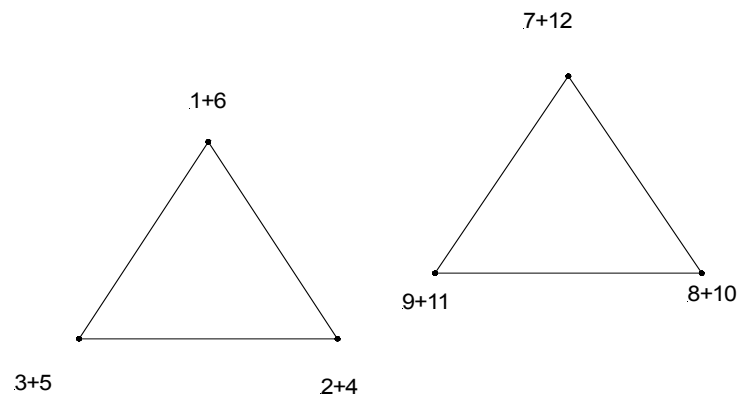

T1	T2	T3
1+6	2+4	3+5
T7	T8	T9
7+12	8+10	9+11