

PE254JP-15-2

CLOSE COUPLED PUMP MOTORS

NEMA PREMIUM EFFICIENCY

THREE PHASE, TOTALLY ENCLOSED FAN COOLED, JP FRAME

INVERTER DUTY 10:1 CT; 20:1 VT - NEMA MG1 PART 31

Factory Certified for T2B Class I, Division II, Groups A,B,C & D and Class II, Division II, Groups F & G

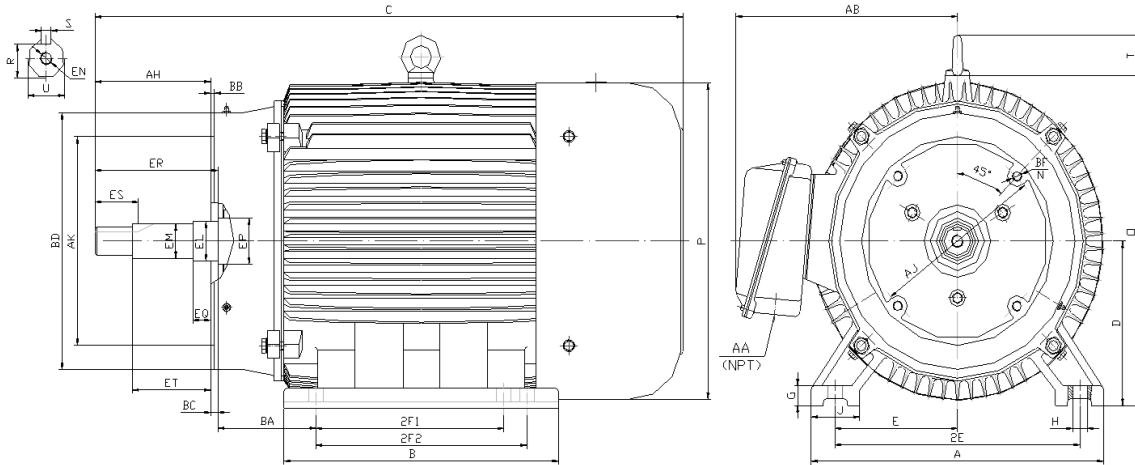

DIMENSIONS

HP	RPM	Frame	MOUNTING														
			A	B	C	D	G	H	J	E	2E	2F1	2F2	O	P	T	BA
15	3600	254JP	13.00	12.20	27.58	6.25	0.70	0.53	2.75	5.00	10.00	8.25	NA	13.00	12.40	2.20	4.75

FLANGE							Shaft Extension, Key Set										
AK	AJ	AH	BB	BC	BD	N*BF	U	R	S	EQ	ER	ES	ET	EP	EL	EM	EN
8.500 8.497	7.25	8.156 8.094	0.312 0.250	0.25	10.0	4*1/2-13	1.2495 1.2490	1.112 1.097	0.252 0.250	2.390 2.360	8.13	2.53	5.890 5.860	1.77	1.750 1.748	1.3750 1.3745	1/2-13

Conduit Box		Bearings		Mount
AA	AB	DE	ODE	
1.25	10.10	6309	6309	F1

BEARING LUBRICATION: The bearings come lubricated with Mobil Polyrex EM Polyurea Grease.





PE254JP-15-2

CLOSE COUPLED PUMP MOTORS

NEMA PREMIUM EFFICIENCY

THREE PHASE, TOTALLY ENCLOSED FAN COOLED, JP FRAME

INVERTER DUTY 10:1 CT; 20:1 VT - NEMA MG1 PART 31







Factory Certified for T2B Class I, Division II, Groups A,B,C & D and Class II, Division II, Groups F & G

PERFORMANCE DATA

HP	RPM	Frame	Voltage	Frequency (Hz)	Full Load S.F.	Insulation Class	NEMA Design	Slip (%)	NEMA Code	Enclosure Type	IP Rating	Max. Ambient
15	3545	254JP	208-230/460	60	1.15	F	B	1.5	G	TEFC	55	40° C

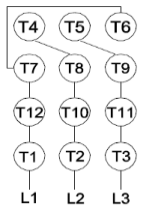
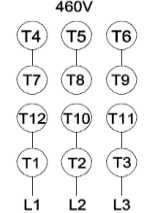
Amps (460V)		Efficiency (%)				Power Factor			Torque (ft-lb)			DE Bearing	ODE Bearing	Connection	Weight (lbs.)
FLA	LRA	100%	75%	50%	Min.	100%	75%	50%	FLT	LRT %	BDT %	6309	6309	12 Lead 2Δ/Δ	261
17.2	116.0	91.0	91.0	90.0	89.5	0.890	0.870	0.800	22.2	150	260				

NAME PLATE

 North American Electric, Inc.													CONNECTION DIAGRAMS 208-230V 		
INVERTER DUTY 20:1 VT; 10:1 CT					CLOSE COUPLED PUMP MOTOR										
CAT NO: PE254JP-15-2			FRAME 254JP			PHASE 3									
HZ 60	S.F. 1.15	HZ 50	S.F. 1.0	ENCL TEFC	IP 55										
HP 15	RPM 3545	HP 15	RPM 2930	DUTY CONT	DES B										
VOLTS 208-230/460		VOLTS 190/380		AMB 40° C	INS F										
FLA 36.2 - 34.4 / 17.2	FLA 42/21			DE BEARING 6309											
CODE G	P.F. 0.89	CODE F	P.F. 0.90	ODE BEARING 6309											
EFF 91.0	MIN 89.5	EFF 89	MIN 87.5	LUB: Mobil Polyrex EM											
MOTOR WEIGHT 261	LBS	CONNECTION 12 Lead 2Δ/Δ		SER NO						460V 					
Specifically designed for use on industrial and commercial pumping units. Hernando, Mississippi										   CC 082A					

APPLICATIONS:

Specifically designed for use on industrial and commercial pumping units.