

PE284T-25-4

GENERAL PURPOSE ELECTRIC MOTOR

NEMA PREMIUM EFFICIENCY

TOTALLY ENCLOSED FAN COOLED

INVERTER DUTY 10:1 CT; 20:1 VT - NEMA MG1 PART 31

Factory Certified for T2B Class I, Division II, Groups A,B,C & D and Class II, Division II, Groups F & G

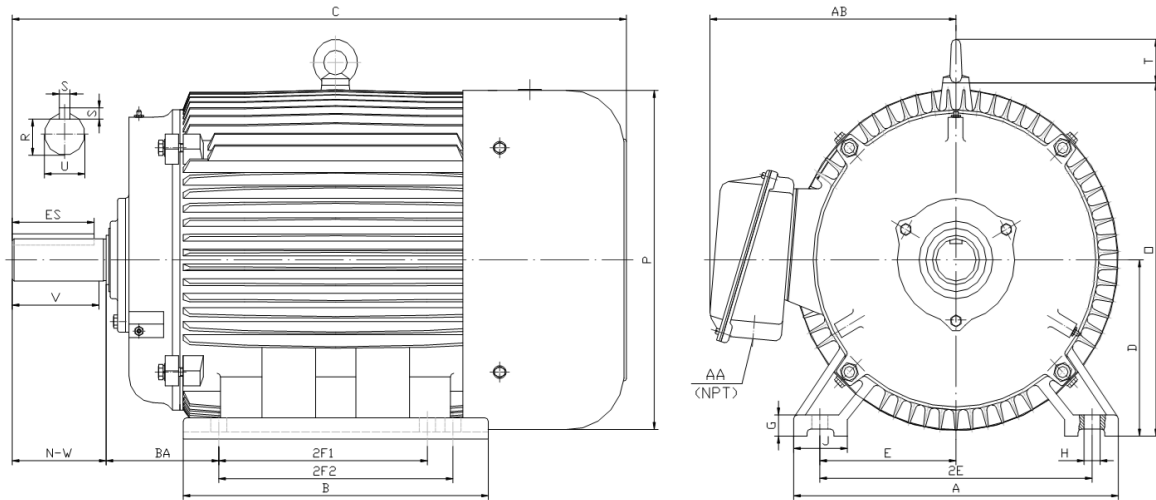

DIMENSIONS

HP	RPM	Frame	MOUNTING														
			A	B	C	D	G	H	J	E	2E	2F1	2F2	O	P	T	BA
25	1800	284T	14.00	13.20	26.60	7.00	0.85	0.53	2.75	5.50	11.00	9.50	0.00	14.50	14.00	2.20	4.75

Shaft Extension, Key Set						Conduit Box		Bearings		Mount
U	V	R	S	ES	N-W	AA	AB	DE	ODE	
1.875	4.38	1.591	0.500	3.28	4.62	1.50	11.30	6311	6311	F1

BEARING LUBRICATION: The bearings come lubricated with Mobil Polyrex EM Polyurea Grease. It is recommended that you add some additional lubrication when the motor is installed.

Three options (brands) for suitable lubrication include, but are not limited to, the following:

- 1.) Mobil Polyrex EM
- 2.) Citco Polyurea MP
- 3.) Conoco Phillips Polytac EP





PE284T-25-4

GENERAL PURPOSE ELECTRIC MOTOR

NEMA PREMIUM EFFICIENCY

TOTALLY ENCLOSED FAN COOLED

INVERTER DUTY 10:1 CT; 20:1 VT - NEMA MG1 PART 31







Factory Certified for T2B Class I, Division II, Groups A,B,C & D and Class II, Division II, Groups F & G

PERFORMANCE DATA

HP	RPM	Frame	Voltage	Frequency (Hz)	Full Load S.F.	Insulation Class	NEMA Design	Slip (%)	NEMA Code	Enclosure Type	IP Rating	Max. Ambient
25	1775	284T	208-230/460	60	1.15	F	B	1.4	G	TEFC	55	40° C

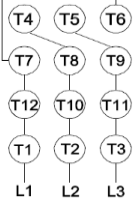
Amps (460V)		Efficiency (%)				Power Factor			Torque (ft-lb)			DE Bearing	ODE Bearing	Connection	Weight (lbs.)
FLA	LRA	100%	75%	50%	Min.	100%	75%	50%	FLT	LRT %	BDT %				
30.0	182	93.6	93.6	93.0	92.4	0.840	0.810	0.720	74.3	160	255	6311	6311	12 Lead 2Δ/Δ	364

NAME PLATE

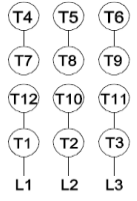
 North American Electric, Inc.													CONNECTION DIAGRAMS 208-230V 										
INVERTER DUTY 20:1 VT; 10:1 CT																							
CAT NO:		PE284T-25-4				FRAME		284T		PHASE		3											
HZ		60		S.F.		1.15		HZ		50		S.F.					1.0		ENCL		TEFC		IP
HP		25		RPM		1775		HP		25		RPM		1465		DUTY		CONT		DES		B	
VOLTS				208-230/460				VOLTS				190/380				AMB		40° C		INS		F	
FLA		65 - 60 / 30				FLA				72/36				DE BEARING				6311					
CODE		G		P.F.		0.84		CODE		F		P.F.		0.86		ODE BEARING				6311			
EFF		93.6		MIN		92.4		EFF		92.3		MIN		91.1		LUB: Mobil Polyrex EM							
MOTOR WEIGHT		364		LBS		CONNECTION				12 Lead 2Δ/Δ				SER NO									
General purpose use on industrial machinery installed in damp, dusty or dirty environments. Hernando, Mississippi																CC 082A		460V 					

APPLICATIONS:

General purpose use on pumps, fans, blowers, compressors, conveyors, material handling and other industrial machinery installed in damp, dusty or dirty environments.