

PE364T-60-4-ODP

GENERAL PURPOSE ELECTRIC MOTOR

NEMA PREMIUM EFFICIENCY

CAST IRON CONSTRUCTION - OPEN DRIP PROOF

INVERTER DUTY 10:1 CT; 20:1 VT - NEMA MG1 PART 31

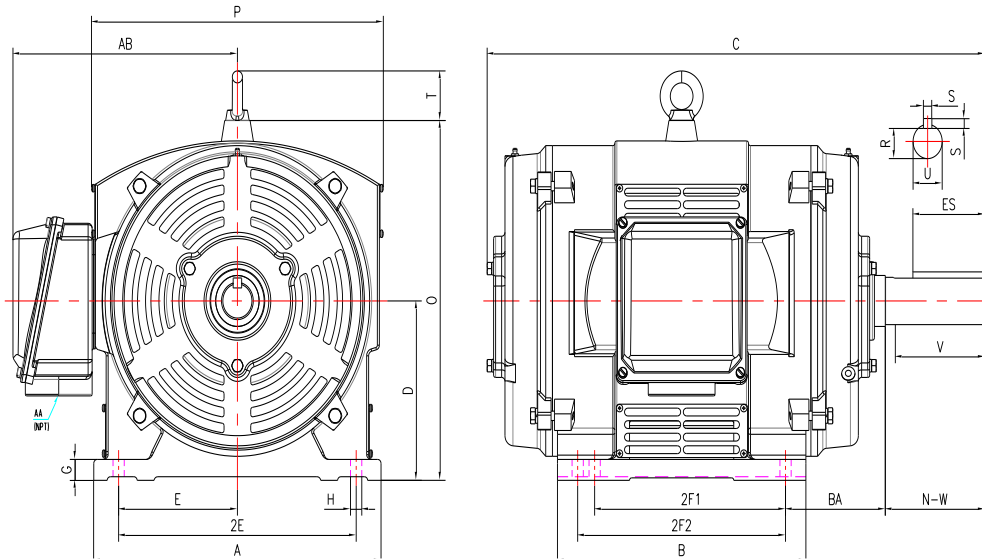

DIMENSIONS

HP	RPM	Frame	MOUNTING														
			A	B	C	D	G	H	J	E	2E	2F1	2F2	O	P	T	BA
60	1800	364T	17.00	14.65	29.30	9.00	1.05	0.66	NA	7.00	14.00	11.25	12.25	18.10	17.20	2.60	5.88

Shaft Extension, Key Set						Conduit Box		Bearings		Mount
U	V	R	S	ES	N-W	AA	AB	DE	ODE	
2.38	5.62	2.02	0.63	4.28	5.88	3.00	12.40	6313	6313	F1

BEARING LUBRICATION: The bearings come lubricated with Mobil Polyrex EM Polyurea Grease. It is recommended that you add some additional lubrication when the motor is installed.

Three options (brands) for suitable lubrication include, but are not limited to, the following:

- 1.) Mobil Polyrex EM
- 2.) Citco Polyurea MP
- 3.) Conoco Phillips Polytac EP





PE364T-60-4-ODP

GENERAL PURPOSE ELECTRIC MOTOR

NEMA PREMIUM EFFICIENCY

CAST IRON CONSTRUCTION - OPEN DRIP PROOF







INVERTER DUTY 10:1 CT; 20:1 VT - NEMA MG1 PART 31

PERFORMANCE DATA

HP	RPM	Frame	Voltage	Frequency (Hz)	Full Load S.F.	Insulation Class	NEMA Design	Slip (%)	NEMA Code	Enclosure Type	IP Rating	Max. Ambient
60	1780	364T	208-230/460	60	1.15	F	B	1.11	G	ODP	23	40° C

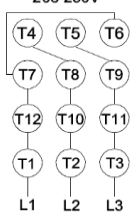
Amps (460V)		Efficiency (%)				Power Factor			Torque (ft-lb)			DE Bearing	ODE Bearing	Connection	Weight (lbs.)
FLA	LRA	100%	75%	50%	Min.	100%	75%	50%	FLT	LRT %	BDT %	6313	6313	12 Lead 2Δ/Δ	726
70.0	435.0	95.0	94.5	95.0	94.1	0.84	0.82	0.74	177.6	160	240				

NAME PLATE

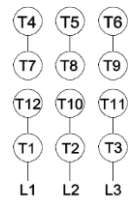
 North American Electric, Inc.															CONNECTION DIAGRAMS 208-230V 					
INVERTER DUTY 20:1 VT; 10:1 CT																				
CAT NO: PE364T-60-4-ODP				FRAME 364T				PHASE 3												
HZ 60		S.F. 1.15		HZ 50		S.F. 1.0		ENCL ODP		IP 23										
HP 60		RPM 1780		HP 60		RPM 1480		DUTY CONT		DES B										
VOLTS 208-230/460				VOLTS 190/380				AMB 40° C				INS F								
FLA 155 - 140 / 70		FLA 168/84				DE BEARING 6313														
CODE G		P.F. 0.84		CODE D		P.F. 0.86		ODE BEARING 6313												
EFF 95.0		MIN 94.1		EFF 93.8		MIN 92.6		LUB: Mobil Polyrex EM												
MOTOR WEIGHT 726 LBS		CONNECTION 12 Lead 2Δ/Δ				SER NO														
General purpose use on industrial machinery installed in environments with minimal dirt and moisture. Hernando, Mississippi																CC 082A				
						460V 														

APPLICATIONS:

General purpose use on pumps, fans, blowers, compressors, conveyors, material handling and other industrial machinery installed in environments with minimal dirt and moisture.