

PEXP143TC-1-4

EXPLOSION PROOF ELECTRIC MOTOR

NEMA PREMIUM EFFICIENCY

TOTALLY ENCLOSED FAN COOLED; EXPLOSION PROOF ENCLOSURE

CLASS I DIVISION I GROUP C & D; CLASS II DIVISION I GROUP F & G

OPERATING TEMP CODE T3C

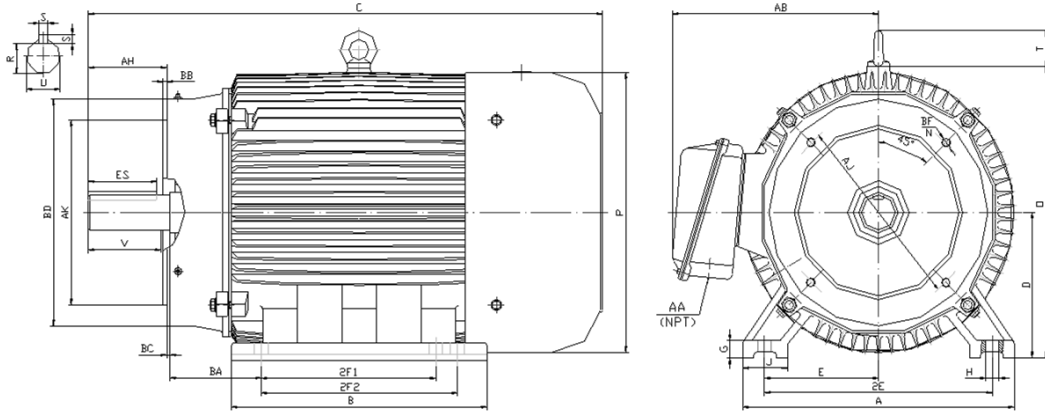

DIMENSIONS

HP	RPM	Frame	MOUNTING														
			A	B	C	D	G	H	J	E	2E	2F1	2F2	O	P	T	BA
1	1800	143TC	7.00	5.20	12.60	3.50	0.50	0.34	1.40	2.75	5.50	4.00	0.00	7.10	6.95	0.00	2.25

FLANGE							Shaft Extension, Key Set						Conduit Box		Bearings		Mount
AH	AJ	AK	BB	BC	BD	BF	U	V	R	S	ES	N-W	AA	AB	DE	ODE	
2.12	5.88	4.50	0.16	0.12	6.50	4*3/8-16	0.88	2.00	0.77	0.19	1.41	2.25	0.75	6.10	6205-ZZ	6205-ZZ	F1

BEARING LUBRICATION: The bearings come lubricated with Mobil Polyrex EM Polyurea Grease.









PEXP143TC-1-4
EXPLOSION PROOF ELECTRIC MOTOR
NEMA PREMIUM EFFICIENCY
TOTALLY ENCLOSED FAN COOLED; EXPLOSION PROOF ENCLOSURE
CLASS I DIVISION I GROUP C & D; CLASS II DIVISION I GROUP F & G
OPERATING TEMP CODE T3C
PERFORMANCE DATA

HP	RPM	Frame	Voltage	Frequency (Hz)	Full Load S.F.	Insulation Class	NEMA Design	Slip (%)	NEMA Code	Enclosure Type	IP Rating	Max. Ambient	Oper Temp Code	Max. KVAR
1	1773	143TC	208-230/460	60	1.15	F	B	1.5	N	TEXP	55	40° C	40° C	0.6

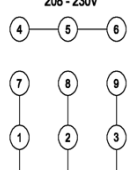
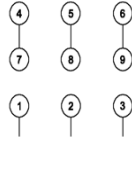
Amps (460V)		Max. Amps (208V)	Efficiency (%)				Power Factor			Torque (ft-lb)			DE Bearing	ODE Bearing	Connection	Weight (lbs.)
FLA	LRA	60HZ	100%	75%	50%	Min.	100%	75%	50%	FLT	LRT %	BDT %	6205-ZZ	6205-ZZ	9 Lead 2Y/Y	62
1.35	15	2.986	85.5	84.5	81.3	82.5	0.785	0.665	0.518	2.96	275	300				

NAME PLATE

 North American Electric, Inc.												CONNECTION DIAGRAMS 208 - 230V  460V 					
PREMIUM EFFICIENT EXPLOSION PROOF MOTOR																	
CAT NO: PEXP143TC-1-4			FRAME 143TC			PHASE 3											
DE BRG 6205-ZZ		ODE BRG 6205-ZZ		CONN. 9 Lead 2Y/Y													
MAX AMB. 40° C		INS. CLASS F		RATING CONT		WEIGHT 62											
USABLE ON 208V 60HZ AT 3.0				MAX AMPS		SER											
DIVISION 1 CLASS I GROUP C D CLASS II GROUP F G						OPER TEMP CODE 40° C											
60 HERTZ DATA			HP 1 RPM 1773			HP 1 RPM 1478			50 HERTZ DATA								
VOLTS 208-230/460			VOLTS 190/380														
F.L. AMPS 1.35			F.L. AMPS 3.3/1.7														
S.F. AMPS 1.6			S.F. AMPS 3.3/1.7														
S.F. 1.15 DESIGN B CODE N			S.F. 1.0 DESIGN B CODE P														
NEMA NOM.EFF. 85.5 % P.F. 0.79			NEMA NOM.EFF. 85.5 % P.F. 0.785														
NEMA MIN.EFF. 82.5 %			NEMA MIN.EFF. 79.0 %														
MAX. KVAR 0.6			LUB. Mobil Polyrex EM														
<small>General purpose use on industrial machinery installed in damp, dusty or dirty environments. These motors are designed for use in hazardous locations defined by class and group.</small>												   CC 041B					
Hernando, Mississippi																	

	ELECTRIC MOTORS FOR HAZARDOUS LOCATIONS CLASS I DIVISION I GROUP C D, CLASS II DIVISION I GROUP F G NO. CCXXXXX E310089

APPLICATIONS:

General purpose use on pumps, fans, blowers, compressors, conveyors, material handling and other industrial machinery installed in damp, dusty or dirty environments. These motors are designed to be used in hazardous locations as defined by class and group.