

**PEXP405TS-100-2**

**EXPLOSION PROOF ELECTRIC MOTOR**

**NEMA PREMIUM EFFICIENCY**

**TOTALLY ENCLOSED FAN COOLED; EXPLOSION PROOF ENCLOSURE**

**CLASS I DIVISION I GROUP C & D; CLASS II DIVISION I GROUP F & G**

**OPERATING TEMP CODE T3C**

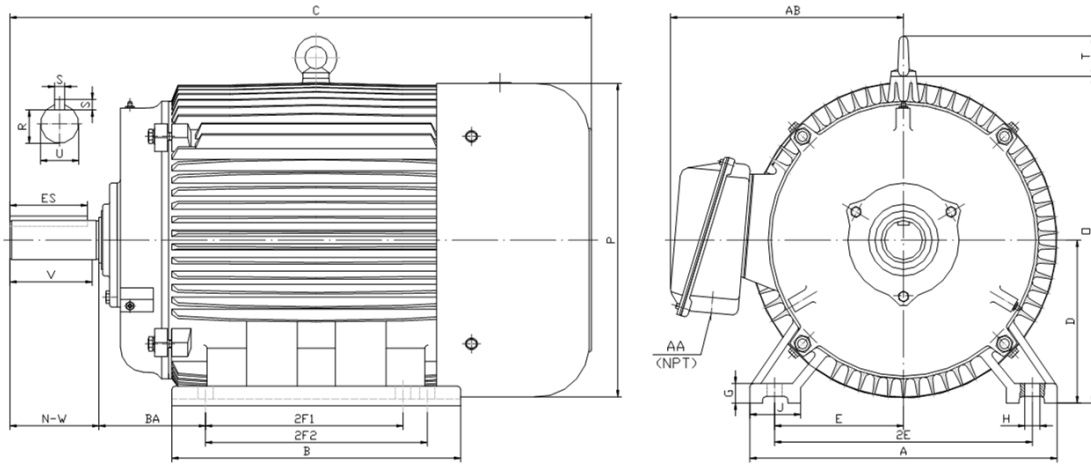

**DIMENSIONS**

HP	RPM	Frame	MOUNTING														
			A	B	C	D	G	H	J	E	2E	2F1	2F2	O	P	T	BA
100	3600	405TS	19.30	17.90	35.00	10.00	1.18	0.81	3.15	8.00	16.00	12.25	13.75	19.80	19.10	2.60	6.62

Shaft Extension, Key Set						Conduit Box		Bearings		Mount
U	V	R	S	ES	N-W	AA	AB	DE	ODE	
2.13	4.00	1.85	0.50	2.78	4.25	3.00	15.60	6313	6313	F1

**BEARING LUBRICATION:** The bearings come lubricated with Mobil Polyrex EM Polyurea Grease. It is recommended that you add some additional lubrication when the motor is installed.

Three options (brands) for suitable lubrication include, but are not limited to, the following:

- 1.) Mobil Polyrex EM
- 2.) Citco Polyurea MP
- 3.) Conoco Phillips Polytac EP









**PEXP405TS-100-2**
**EXPLOSION PROOF ELECTRIC MOTOR**
**NEMA PREMIUM EFFICIENCY**
**TOTALLY ENCLOSED FAN COOLED; EXPLOSION PROOF ENCLOSURE**
**CLASS I DIVISION I GROUP C & D; CLASS II DIVISION I GROUP F & G**
**OPERATING TEMP CODE T3C**
**PERFORMANCE DATA**

HP	RPM	Frame	Voltage	Frequency (Hz)	Full Load S.F.	Insulation Class	NEMA Design	Slip (%)	NEMA Code	Enclosure Type	IP Rating	Max. Ambient	Oper Temp Code	Max. KVAR
100	3579	405TS	208-230/460	60	1.15	F	B	0.6	G	TEXP	55	40° C	T3C	19

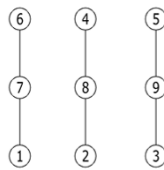
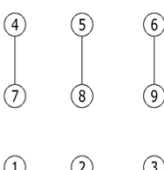
Amps (460V)		Max. Amps (208V)	Efficiency (%)				Power Factor			Torque (ft-lb)			DE Bearing	ODE Bearing	Connection	Weight (lbs.)
FLA	LRA	60HZ	100%	75%	50%	Min.	100%	75%	50%	FLT	LRT %	BDT %				
108.8	725.0	240.6	94.1	94.1	93.7	93.0	0.89	0.90	0.86	147.6	105	200	6313	6313	9 Lead 2Δ/Δ	1393

**NAME PLATE**

 <b>North American Electric, Inc.</b>															<b>CONNECTION DIAGRAMS</b>  <b>208V-230V</b> 				
<b>PREMIUM EFFICIENT EXPLOSION PROOF MOTOR</b>																			
CAT NO: PEXP405TS-100-2			FRAME 405TS			PHASE 3				<b>460V</b> 									
DE BRG 6313		ODE BRG 6313		CONN. 9 Lead 2Δ/Δ															
MAX AMB. 40° C		INS. CLASS F		RATING CONT		WEIGHT 1393													
USABLE ON 208V 60HZ AT 240.6 MAX AMPS				SER															
DIVISION 1 CLASS I GROUP C D CLASS II GROUP F G						OPER TEMP CODE T3C													
60 HERTZ DATA		HP 100		RPM 3579		HP 100		RPM 2983		50 HERTZ DATA									
		VOLTS 208-230/460				VOLTS 190/380													
		F.L. AMPS 240.6 - 217.6 / 108.8				F.L. AMPS 263.4/131.7													
		S.F. AMPS 125.1				S.F. AMPS 263.4/131.7													
		S.F. 1.15 DESIGN B CODE G				S.F. 1.0 DESIGN B CODE H													
		NEMA NOM.EFF. 94.1 % P.F. 0.89				NEMA NOM.EFF. 94.7 % P.F. 0.89													
		NEMA MIN.EFF. 93.0 %				NEMA MIN.EFF. 93.6 %													
MAX. KVAR 19		LUB. Mobil Polyrex EM																	
<small>General purpose use on industrial machinery installed in damp, dusty or dirty environments. These motors are designed for use in hazardous locations defined by class and group.</small>										   <b>CC 041B</b>									
Hernando, Mississippi																			

	<b>ELECTRIC MOTORS FOR HAZARDOUS LOCATIONS</b> CLASS I DIVISION I GROUP C D, CLASS II DIVISION I GROUP F G NO. CCXXXXX E310089
---	--

**APPLICATIONS:**

General purpose use on pumps, fans, blowers, compressors, conveyors, material handling and other industrial machinery installed in damp, dusty or dirty environments. These motors are designed to be used in hazardous locations as defined by class and group.