

V2-15D4-W25410A

VERTICAL HOLLOW SHAFT MOTOR

NEMA PREMIUM EFFICIENCY

INVERTER DUTY 20:1 VT

INCLUDES INSULATED BEARING MOUNT - 40 HP AND ABOVE

HIGH THRUST DESIGN

THREE PHASE, OPEN DRIP PROOF (WP1) ENCLOSURE

NON-REVERSE BALL TYPE RATCHET

COUPLING INCLUDED

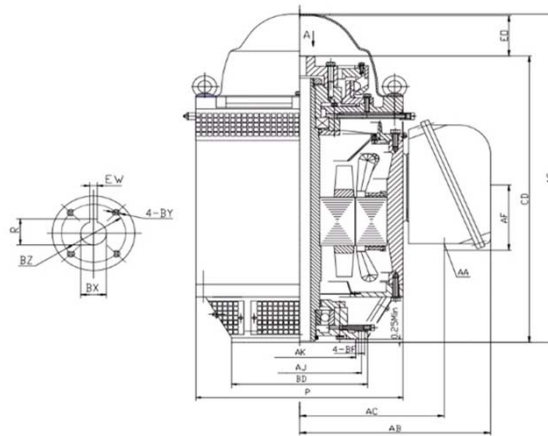

DIMENSIONS

HP	RPM	Frame	MOUNTING DIMENSIONS													
			BD	AJ	AK	BF	BX	BZ	EW	R	BY	CD	E0 >	AC	AA	AF
15	1770	254TP	10.00	9.125	8.25	0.44	1.00	1.38	0.25	1.114	10-32	23.38	4.29	11.65	3" NPT	5.83

OVERALL DIMENSIONS			BEARINGS	
P	AB	AG	UPPER	BOTTOM
17.32	15.07	27.88	6212	7312B

COUPLING: Motor comes with a 1.0" coupling. You may select a different size coupling at no extra charge.

BEARING LUBRICATION: The bottom bearing comes lubricated with Mobil Polyrex EM Polyurea Grease.





V2-15D4-W25410A

VERTICAL HOLLOW SHAFT MOTOR
NEMA PREMIUM EFFICIENCY
INVERTER DUTY 20:1 VT
INCLUDES INSULATED BEARING MOUNT - 40 HP AND ABOVE
HIGH THRUST DESIGN
THREE PHASE, OPEN DRIP PROOF (WP1) ENCLOSURE
NON-REVERSE BALL TYPE RATCHET

PERFORMANCE DATA

HP	RPM	Frame	Voltage	Frequency (Hz)	Full Load S.F.	Insulation Class	NEMA Design	Slip (%)	NEMA Code	Enclosure Type	IP Rating	Max. Ambient	Rating CONT
15	1785	254TP	230/460	60	1.15	F	B	0.8	H	WP1	23	40° C	S1

Amps (460V)		Efficiency (%)				Power Factor			Torque (ft-lb)			Down Thrust	Angular Contact Bearing	Radial Ball Bearing	Connection	Weight (lbs.)
FLA	LRA	100%	75%	50%	Min.	100%	75%	50%	FLT	LRT %	BDT %	3200	UPPER	BOTTOM	12 Lead 2Δ/Δ	595
17.3	128.0	93.0	93.0	91.4	91.7	0.86	0.83	0.74	44.0	218	250	3200	6212	7312B		

NAME PLATE

				VERTICAL HOLLOW SHAFT ELECTRIC MOTOR				CONNECTION DIAGRAMS			
INVERTER DUTY 20:1 VT				HIGH THRUST DESIGN				208-230V			
MODEL		V2-15D4-W25410A		PHASE		3 Hz 60					
HP	15	FRAME	254TP	VOLTS		230/460					
DESIGN	B	CODE	H	AMPS		34.6/17.3					
NOM EFF.	93.0	P.F.	0.86	INSULATION CLASS		F					
RATING CONT	S1	S.F.	1.15	MAX AMB.	40° C	WEIGHT	595 LBS.				
DOWN THRUST		3200		ENCLOSURE TYPE		WP1					
UPPER BEARING		6212		BOTTOM BEARING		7312B					
LUBRICATION		MOBILE POLYREX EM		LUBRICATION		MOBILE POLYREX EM					
NON-REVERSE RATCHET - BALL TYPE				SERIAL NO.							
Specifically designed for use on deep well turbine pump applications. Hernando, Mississippi								PART WIND START CAPABLE @ 230V			

APPLICATIONS:

Specifically designed for use on deep well turbine pump applications. The coupling is equipped with a non-reverse ratchet, which prevents motor rotation from backspin at shutdown. These motors are built to NEMA standards and have special bearing arrangements to carry heavy thrust loads.