

Dimensional Drawing

Catalogue	Model	HP	Pole	kW	Rating	Voltage	Hz	RPM
APH3002-841	AEHH8B	300	2	224	Continuous	460 V	60	3600

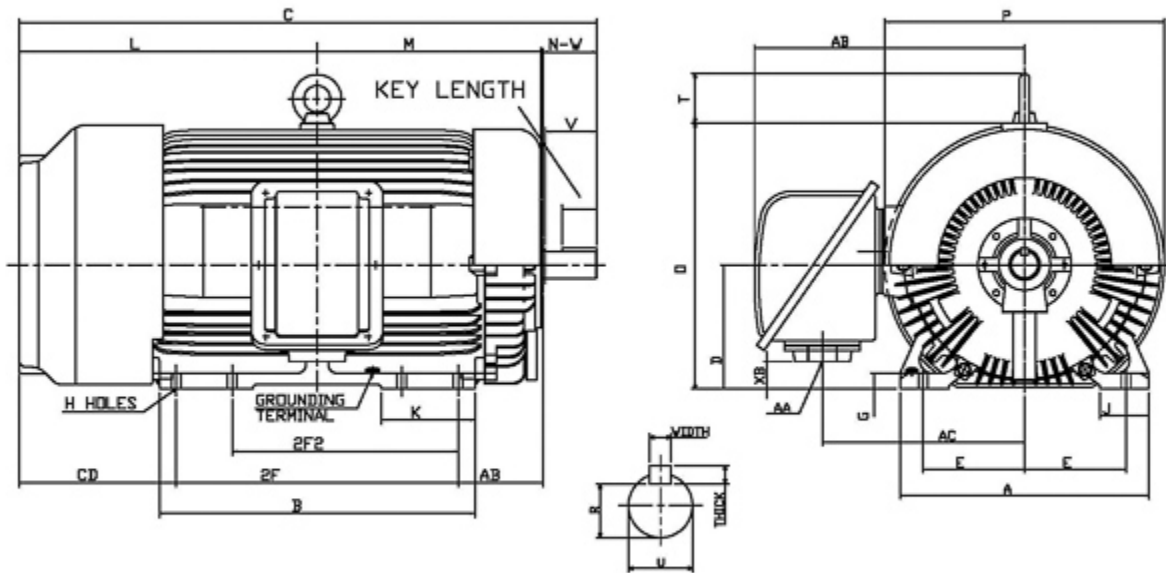

Frame Size	Mounting					A	B	C	CD	D	
	E	2F	2F2	H	BA						
449TS	9	25	20	0.81	7.5	22.05	27.95	51.15	13.9	11	
G	J	K	L	M	O	P	T	Key			Keyseat
1.4	4.35	8.25	26.4	19.65	23.55	24.75	7.33	Width	Thick	Length	R
								0.625	0.625	3.03	2.021
Terminal Housing			Aux Box			C/D Flange					
AA	AB	AC	XB	AE	AX	BB	AH	AK	BD	AJ	BF
-	31.11	21.02	3.95								
Shaft Extension			Bearings		Approx. Weight Lbs	SPL dBA/3ft	Ins. Class	S.F.	Drive Method	Dimensions	
N-W	U	V	DE	NDE							
4.75	2.375	4.5	6314C3	6314C3	2493	83	F	1.15	Direct Coupling	Inches	

Technical Data Sheet

Motor Type: AEHH8B

Catalogue No: APH3002-841

Nameplate Information

HP	Pole	RPM	Frame	Voltage	Hz	Phase
300	2	3583	449TS	460	60	3
Enclosure	Ins. Class	Service Factor	Time Rating	NEMA Design	Rated Amb.	Rated Altitude
TEFC	F	1.15	Continuous	B	-40 to 40 °C	<3300 ft

Typical Performance

Efficiency (%)				Power Factor (%)		
Full Load		3/4 Load	1/2 Load	Full Load	3/4 Load	1/2 Load
Nom.	Min.					
95.8	95.0	95.4	94.5	88.0	85.5	82.5
Torque				Current (A)		
Full Load (lb-ft)	Locked Rotor (% FLT)	Pull Up (% FLT)	Break Down (% FLT)	No Load	Full Load	Locked Rotor
439.00	102	81	210	50.5	333.2	2220
NEMA KVA Code	Inertia (WR ²)			Safe Stall Time (s)		Noise Level Sound Press. dB(A)
	Rotor (lb-ft ²)	NEMA Load (lb-ft ²)	Max. Allowable (lb-ft ²)	Cold	Hot	
0	52.500	246	246	22	15	83

VFD Duty Information

Speed Range			VFD		S.F.
Constant Torque	Variable Torque	Constant Power	Carrier	Type	
20-60Hz	3-60Hz	60-60Hz	≤ 5 kHz	VPWM or CPWM	0

Additional Information

Bearings		Approx. Weight
DE	NDE	lbs
6314C3	6314C3	2493

Hazardous Locations Information

CSA Certified	
Class I, Div 2, Groups B, C & D Class I, Zone 2, Groups IIB+H2, IIB & IIA	
Temp Code (Sinewave / VFD)	T3C / T3